

aiwa

AV SURROUND RECEIVER
RECEPTOR CON SISTEMA DE SONIDO PERIMÉTRICO PARA AUDIO-VÍDEO
RECEPTEUR AV SURROUND

AV-NW30
AV-NW31 (for HT-NW300, HT-DV2300)

OPERATING INSTRUCTIONS
MANUAL DE INSTRUCCIONES
MODE D'EMPLOI

En (English)

E (Español)

F (Français)

Owner's record

For your convenience, record the model number and serial number (you will find them on the rear of your unit) in the space provided below. Please refer to them when you contact your Aiwa dealer in case of difficulty.

Model No.	Serial No. (Lot No.)
AV-NW30/AV-NW31	

For assistance and information

call toll free 1-800-BUY-AIWA

(United States and Puerto Rico)

WARNING

TO REDUCE THE RISK OF FIRE OR ELECTRIC SHOCK, DO NOT EXPOSE THIS APPLIANCE TO RAIN OR MOISTURE.



Explanation of Graphical Symbols:



The lightning flash with arrowhead symbol, within an equilateral triangle, is intended to alert the user to the presence of uninsulated "dangerous voltage" within the product's enclosure that may be of sufficient magnitude to constitute a risk of electric shock to persons.



The exclamation point within an equilateral triangle is intended to alert the user to the presence of important operating and maintenance (servicing) instructions in the literature accompanying the appliance.

IMPORTANT SAFETY INSTRUCTIONS

Read the Operating Instructions carefully and completely before operating the unit. Be sure to keep the Operating Instructions for future reference. All warnings and cautions in the Operating Instructions and on the unit should be strictly followed, as well as the safety suggestions below.

Warning

To prevent electric shock or injury, these safety instructions should be followed in the installation, use and servicing the unit.

Installation

Attachments - Do not use attachments not recommended by the unit manufacturer as they may result in the risk of fire, electric shock or injury to persons.

Water and Moisture - Do not use this unit near water - for example, near a bathtub, washbowl, kitchen sink, or laundry tub, in a wet basement, or near a swimming pool, and the like.

Heat - Do not use this unit near sources of heat, including heating vents, stoves, or other appliances that generate heat. It also should not be placed in temperatures less than 5°C (41°F) or greater than 35°C (95°F).

Mounting surface - Place the unit on a flat, even surface.

Accessories - Do not place this unit on an unstable cart, stand, tripod, bracket, or table. The unit may fall, causing serious injury to a child or an adult, and serious damage to the appliance. Use only with a cart, stand, tripod, bracket, or table recommended by the manufacturer, or sold with the unit. Any mounting of the appliance should follow the manufacturer's instructions, and should use a mounting accessory recommended by the manufacturer.

Portable cart - An appliance and cart combination should be moved with care. Quick stops, excessive force, and uneven surfaces may cause the appliance and cart combination to overturn.



Ventilation - The unit should be situated with adequate space around it so that proper heat ventilation is assured. Allow 10 cm clearance from the rear and the top of the unit, and 5 cm from the each side.

Slots and openings in the cabinet and the back or bottom are provided for ventilation, and to ensure reliable operation of the unit and to protect it from overheating, these openings must not be blocked or covered. The openings should never be blocked by placing the unit on a bed, sofa, rug or other similar surface. This unit should not be placed in a built-in installation such as a bookcase unless proper ventilation is provided.

Object and Liquid Entry - Never push objects of any kind into this unit through the cabinet slots as they may touch dangerous voltage points or short-circuit parts that could result in a fire or electric shock. Never spill liquid of any kind on the unit.

Electric Power

Power Sources - This unit should be operated only from the type of power source indicated on the marking label. If you are not sure of the type of power supply to your home, consult your appliance dealer or local power company. To operate unit on battery power, or other sources, refer to the operating instructions.

Grounding or Polarization - This unit is provided with a polarized alternating-current line plug (a plug having one blade wider than the other). This plug will fit into the power outlet only one way. This is a safety feature. If you are unable to insert the plug fully into the outlet, try reversing the plug. If the plug should still fail to fit, contact your electrician to replace your obsolete outlet. Do not defeat the safety purpose of the polarized plug.

Power-Cord Protection - Power-supply cords should be routed so that they are not likely to be walked on or pinched by items placed upon or against them, paying particular attention to cords at plugs, convenience receptacles, and the point where they exit from the product.

Overloading - Do not overload wall outlets, extension cords, integral convenience receptacles as this can result in a risk of fire or electric shock.

Outdoor Antenna

Power lines - An outside antenna system should not be located in the vicinity of overhead power lines or other electric light or power circuits, or where it can fall into such power lines or circuits. When installing an outside antenna system, extreme care should be taken to keep from touching such power lines or circuits as contact with them might be fatal.

Outdoor Antenna Grounding - If an outside antenna or cable system is connected to the unit, be sure the antenna or cable system is grounded so as to provide some protection against voltage surges and built-up static charges. Section 810 of the National Electrical Code, ANSI/NFPA No.70, provides information with regard to proper grounding of the mast and supporting structure, grounding of the lead-in wire to an antenna discharge unit, size of grounding conductors, location of antenna-discharge unit, connection to grounding electrodes, and requirements for the grounding electrode. See the figure.

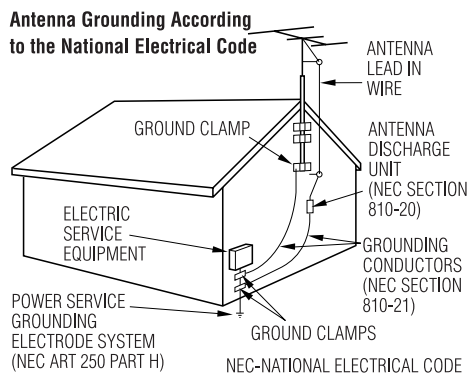

Note to CATV system installer:

This reminder is provided to call the CATV system installer's attention to Section 820-40 of the NEC which provides guidelines for proper grounding and, in particular, specifies that the cable ground shall be connected to the grounding system of the building, as close to the point of cable entry as practical.

Lightning

For added protection for this unit receiver during a lightning storm, or when it is left unattended and unused for long periods of time, unplug it from the wall outlet and disconnect the antenna or cable system. This will prevent damage to the unit due to lightning and powerline surges.

Maintenance

Cleaning - Unplug this unit from the wall outlet before cleaning. Do not use liquid cleaners or aerosol cleaners. Use a damp cloth for cleaning.

Damage Requiring Service

Unplug this unit from the wall outlet and refer servicing to qualified service personnel under the following conditions:

- 1) When the power cord or plug is damaged.
- 2) If liquid has been spilled, or objects have fallen into the unit.
- 3) If the unit has been exposed to rain or water.
- 4) If the unit does not operate normally by following the operating instructions. Adjust only those controls that are covered by the operating instructions as improper adjustment of other controls may result in damage and will often require extensive work by a qualified technician to restore the unit to normal operation.
- 5) If the unit has been dropped or the cabinet has been damaged.
- 6) When the unit exhibits a distinct change in performance - this indicates a need for service.

Do not attempt to service this unit yourself as opening or removing covers may expose you to dangerous voltage or other hazards. Refer all servicing to qualified service personnel.

Replacement Parts - When replacement parts are required, be sure the service technician has used replacement parts specified by the manufacturer or having the same characteristics as the original part. Unauthorized substitutions may result in fire, electric shock or other hazards.

Safety Check - Upon the completion of any service or repairs to this unit, ask the service technician to perform safety checks to determine that the unit is in proper operating condition.

TABLE OF CONTENTS

IMPORTANT SAFETY INSTRUCTIONS 2

PREPARATIONS

CONNECTIONS 4

BEFORE OPERATION 8

SOUND

CUSTOM AUDIO ADJUSTMENT 9

DSP SURROUND 9

BASIC OPERATIONS

SELECTION OF AUDIO/VIDEO SOURCE 10

RECORDING AN AUDIO SOURCE 11

RADIO RECEPTION

MANUAL TUNING 12

PRESET TUNING 12

DOLBY SURROUND AND DTS SURROUND

TURNING SURROUND ON AND OFF 13

SETTING SPEAKER SIZE AND DISTANCE 14

ADJUSTING SPEAKER LEVEL BALANCE 15

OTHER SETTINGS 16

TIMER

SETTING THE SLEEP TIMER 17

GENERAL

CARE AND MAINTENANCE 17

TROUBLESHOOTING GUIDE 17

SPECIFICATIONS 18

PARTS INDEX 19

En

Check your accessories

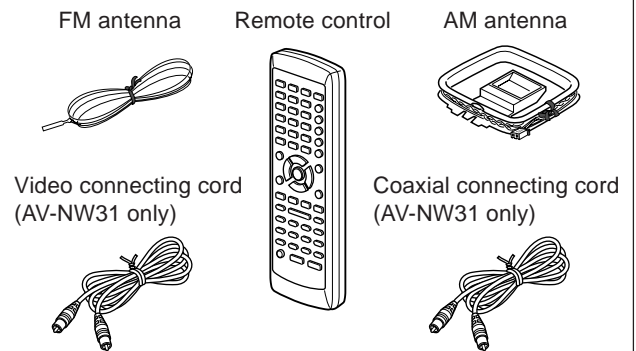

Operating Instructions, etc.

For the customers who bought the AV-NW31 (for HT-NW300 and HT-DV2300)

- For the connections and operations of the speaker system and the DVD player, refer also to the operating instructions supplied with the speaker system (for HT-NW300 and HT-DV2300) or the DVD player (for HT-DV2300).
- The optical connecting cord is also supplied to the system HT-DV2300).

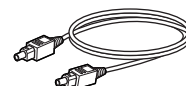

CONNECTIONS

Before connecting the AC cord

The rated voltage of your unit shown on the rear panel is 120 V AC. Check that the rated voltage matches your local voltage.

IMPORTANT

Plug in the AC power cord to the AC outlet after all other connections are made.

CONNECTING EQUIPMENT

Jacks and plugs of the connecting cord are color-coded as follows:
 Red jacks and plugs: For the right channel of audio signals
 White jacks and plugs: For the left channel of audio signals
 Yellow jacks and plugs: For video signals

NOTE

Insert the plugs fully into the jacks. Loose connections may produce a humming sound or other noise interference.

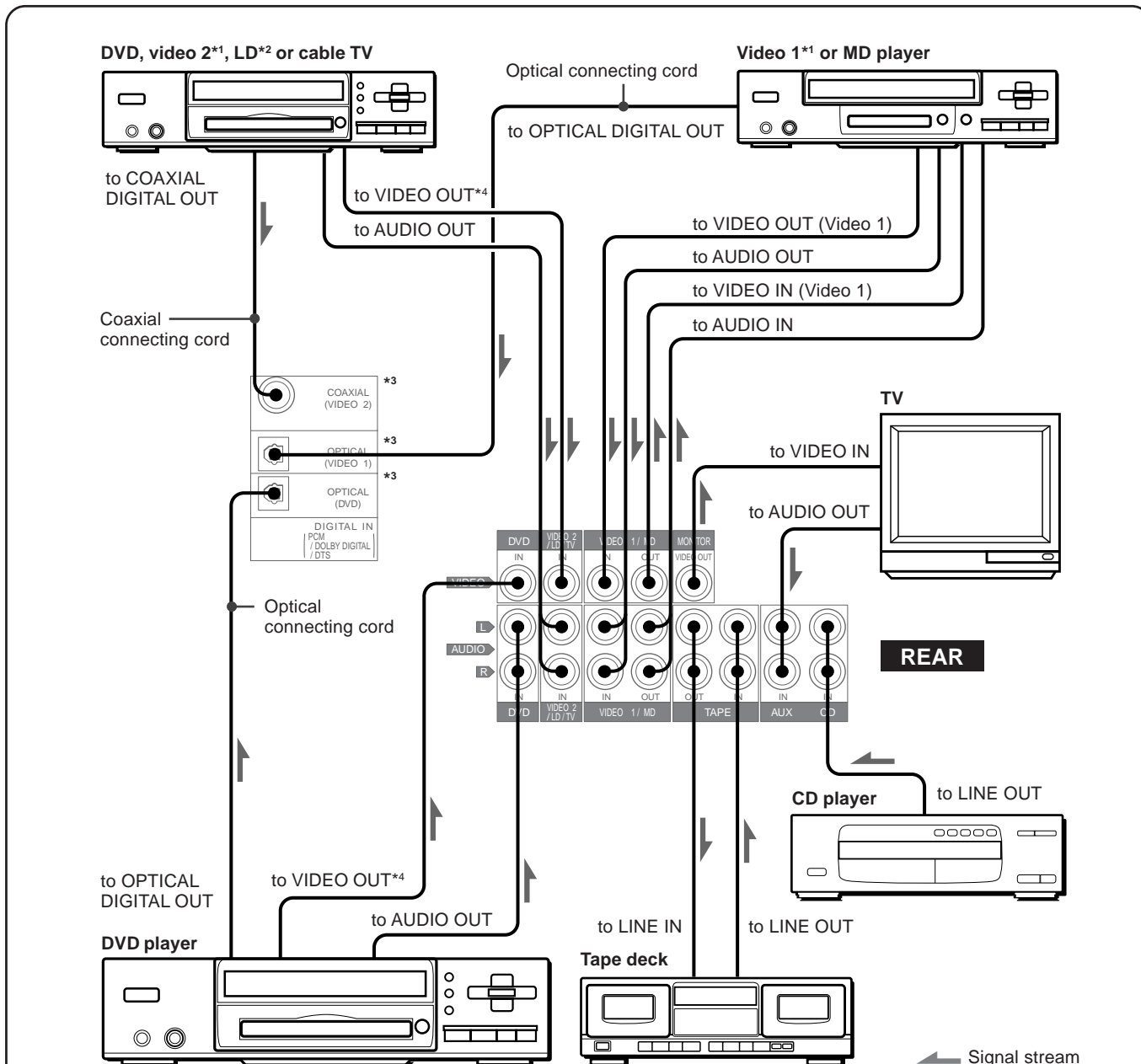

*1 When connecting a monaural video, use a stereo-mono connecting cord (not supplied).

*2 When connecting an LD player equipped with the AC-3 RF OUT terminal, use an RF demodulator unit. Also connect the analog AUDIO OUT terminals of the LD player to the receiver to play all the sources. For further information, refer to the instructions of the LD player.

*3 Input sound through the DIGITAL IN terminals (COAXIAL (VIDEO 2), OPTICAL (VIDEO 1) and OPTICAL (DVD)) cannot be recorded. When recording the sound from the DVD, CD, MD or LD player, connect the analog AUDIO OUT terminals of the player to the corresponding AUDIO IN terminals of the receiver.

*4 With this connection, the picture noise may appear when playing copy protected DVDs. In this case, it is recommended to connect the VIDEO OUT terminal of the DVD player directly to a TV set, not through the receiver.

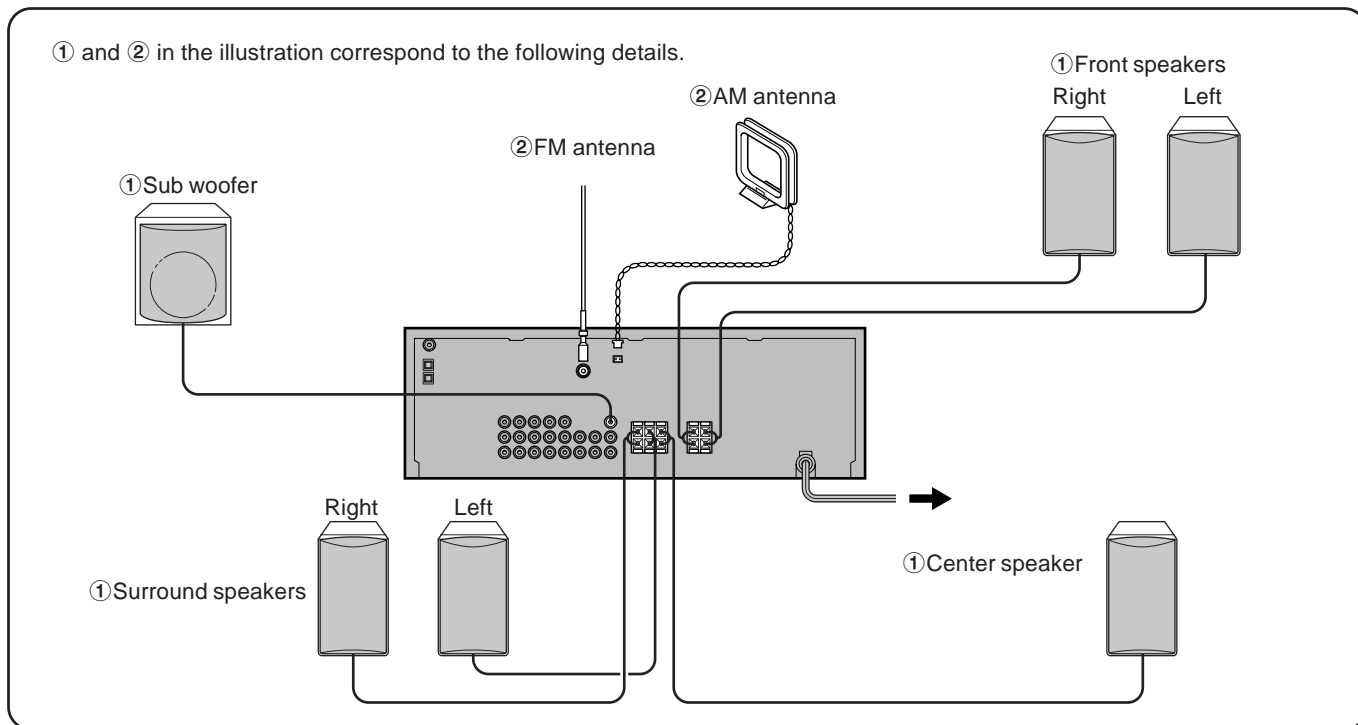

CONNECTING SPEAKERS ①

Speaker terminals

Connect front speakers, a center speaker, surround speakers and a sub woofer to the corresponding speaker terminals on the unit:

- the front speaker cords to the FRONT SPEAKERS terminals
- the center speaker cord to the CENTER SPEAKER terminals
- the surround speaker cords to the SURROUND SPEAKERS terminals
- the sub woofer (with a built-in amplifier) cord to the SUB WOOFER jack, for more powerful bass sounds
- **When not connecting the sub woofer**, be sure to select "SUBW OFF" (sub woofer off) mode (see the next page).
- **When not connecting the center speaker and/or surround speakers, and regarding to the size of speakers (including front speakers), speaker settings must be done.** Before using the unit, be sure to make speaker settings in accordance with your speaker configuration (see page 14).

Speaker impedance

For all speakers, use speakers of 8 ohms or more.

Connecting + to +, - to - terminals

To get the proper sound effect, the speaker terminals on the unit and the speaker should be connected with proper polarity; the + terminal on the unit should be connected to the + terminal on the speaker (and - to -).

NOTE

- Be sure to connect the speaker cords correctly as shown in the illustration on the right column. Improper connections can cause short circuits in the SPEAKER(S) terminals.
- Do not leave objects generating magnetism near the speakers.

Do not put any equipment such as DVD players and speakers on the receiver to assure proper heat ventilation.

Front speakers

Lift up the terminal flap, insert the speaker cord lead into the terminal slot, then close the flap. Check that the cord is connected securely.

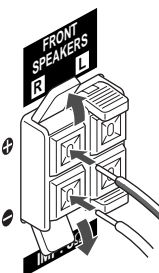

Surround speakers

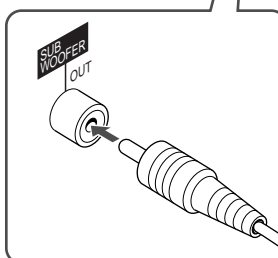
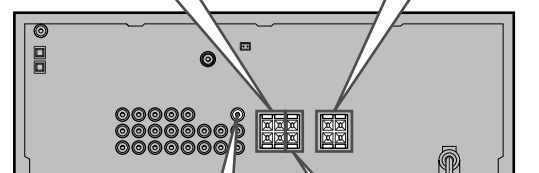
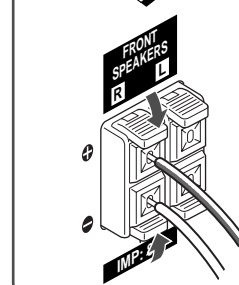
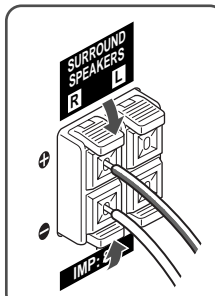

Sub woofer

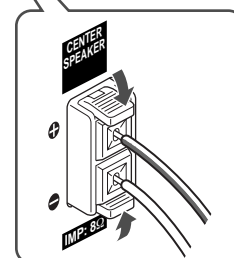

Center speaker

POSITIONING THE SPEAKERS

Position the speakers to make the most of Dolby, DTS or DSP surround effect.

Front speaker (L/R)

Center speaker (C)

Position in the center of the two front speakers. In addition, position on or below the TV set, if connecting a TV set to the unit.

Surround speakers (LS/RS)

Place the surround speakers directly to the side of or slightly behind the listening area. Align them horizontally, about 1 meter (3.2 feet) above ear height.

Sub woofer (SW)

Place the sub woofer in any place near the two front speakers.

When not connecting the sub woofer

Select the "SUBW OFF" mode.

- 1 Press and hold SPEAKERS until "FR LARGE" is displayed.
- 2 Within 6 seconds, turn MULTI JOG so that "SUBW ON" is displayed.
- 3 Press ENTER.
- 4 Within 6 seconds, turn MULTI JOG so that "SUBW OFF" is displayed, then press ENTER.

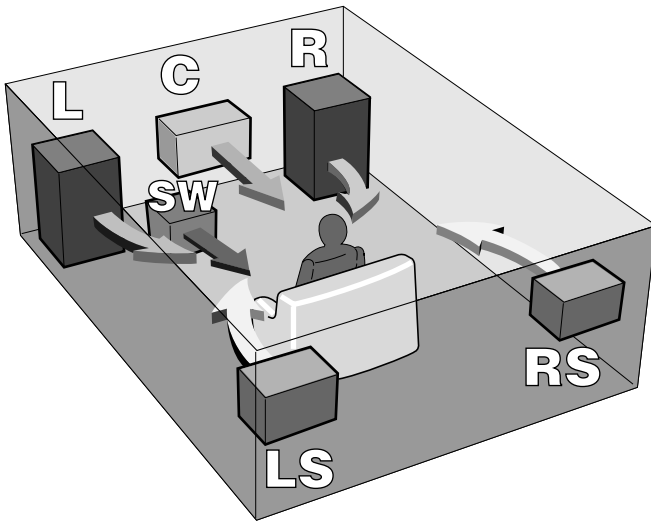

Turning on/off the front speakers

Each time you press SPEAKERS on the front panel, the front speakers are turned on and off. When the front speakers are turned on, "SP" lights up on the display window.

NOTE

- When you turn off the front speakers, the surround mode (Dolby Digital, Dolby Pro Logic or DTS) or the DSP mode will be canceled.
- When the front speakers are turned off, SURROUND and DSP on the front panel cannot be used. ("CAN'T USE" will be displayed).

CONNECTING THE SUPPLIED ANTENNAS ②

Connect the FM antenna to the FM 75Ω terminal and the AM antenna to the AM LOOP jack.

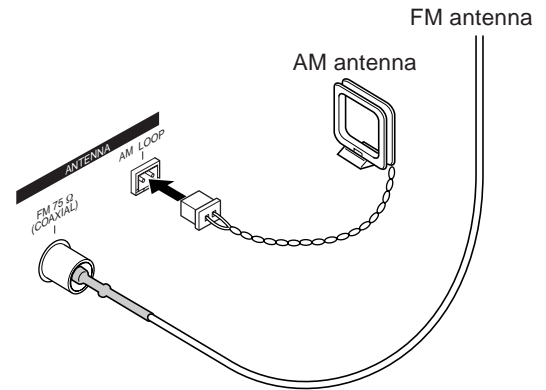

To stand the AM loop antenna on a surface

Fix the claw to the slot as shown in the illustration.

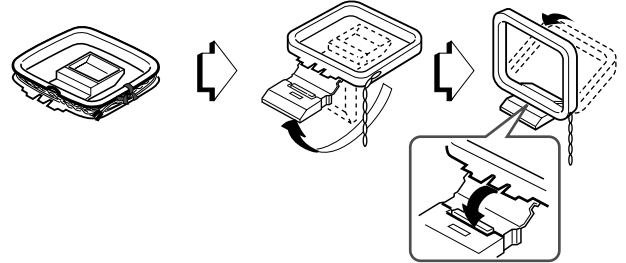

To position the antennas

Keep antennas away from metallic objects, electrical equipment (including the unit itself) and cords.

FM antenna: Extend fully and position for the best reception. If reception is poor, connect an optional outdoor antenna to the FM 75Ω terminal.

AM antenna: Rotate to find best reception.

ABOUT THE REMOTE CONTROL

Inserting batteries

Detach the battery cover on the rear of the remote control and insert two R6 (size AA) batteries.

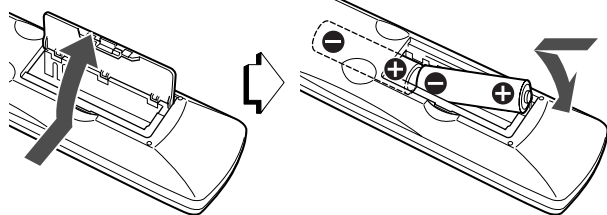

- Replace the batteries with new ones when the operational distance between the remote control and the main unit becomes shorter.
- Remove the batteries if the unit is not going to be used for an extended period of time.
- The remote control may not operate if it is used under intense sunlight or if its line of sight is obstructed.

Important

ENTER on the remote control substitutes for ENTER on the main unit when the function is TUNER. In other functions, this button is mainly for operating the DVD player (see the right column).

To select the function with the remote control

Press FUNCTION repeatedly. The function changes cyclically.

Operating AIWA equipment with the remote control

You can control the basic functions of AIWA video recorder, TV, DVD player or CD player with the remote control.

Note that there are models that cannot be operated with the remote control.

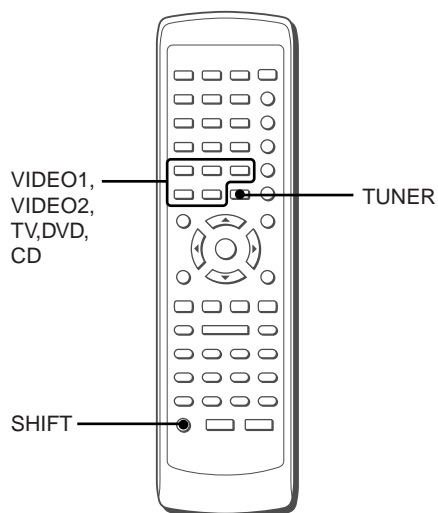

Selecting equipment to be controlled

To control video recorders, press either VIDEO 1 or VIDEO 2, whichever allows you to control correctly the video recorder.

To control a TV, press TV.

To control a DVD player, press DVD.

To control a CD player, press CD.

- There are two sets of transmitted codes for CD, VIDEO 1 and VIDEO 2.

To change the code set for CD, hold down CD and press 0,0,1 or 0,0,2. (When you choose 0,0,2, you can also operate a DVD player with the remote control.)

To change the code set for VIDEO 1 and VIDEO 2, hold down VIDEO 1 or VIDEO 2 respectively and press 4,0,0 or 5,3,3.

To control the receiver (this unit)

Press TUNER.

NOTE

Be sure to press TUNER before operating the receiver (this unit).

Operating video recorders

Press the following buttons.

▶ - Starts playback.

⏸ - Pauses playback.

■ - Stops playback.

◀◀, ▶▶ - Fast rewind/fast forward

TV/VIDEO - Switches between the TV mode and VIDEO mode.

POWER - Turns on/off the power.

0-9, +10 - Selects channel.

◀/▶ or ▼/▲ - Channel down/up.

C - Resets the counter.

▶▶/◀◀ - Skip forward/back to the next/previous scene.

Operating TVs

Press the following buttons.

TV/VIDEO - Switches between the TV mode and VIDEO mode.

POWER - Turns on/off the power.

0-9, +10 - Selects channel.

▼/▲ - Channel down/up.

◀/▶ - Decrease/increase volume.

Operating DVD players

Press the following buttons.

POWER - Turns on/off the power.

▶ - Starts playback.

⏸ - Pauses playback.

■ - Stops playback.

◀◀, ▶▶ - Searches for a track.

◀◀◀, ▶▶▶ - Skips a track.

◀◀, ▶▶ while pressing SHIFT - Enters slow playback mode.

AUDIO while pressing SHIFT - Selects the sound tracks.

SUB TITLE while pressing SHIFT - Changes the subtitle language.

ANGLE while pressing SHIFT - Changes the picture angle.

ON SCREEN while pressing SHIFT - Displays On Screen Display menu.

ZOOM while pressing SHIFT - Zooms in the picture.

PRGM while pressing SHIFT - Enters the programmed play mode.

RANDOM while pressing SHIFT - Enters the random play mode.

REPEAT while pressing SHIFT - Enters the repeat play mode.

TOP MENU - Displays the title menu.

MENU - Displays menu programs.

▲, ▼, ◀, ▶ - Moves the cursor to select a program, etc.

ENTER - Executes or fixes the selected item from a menu.

↶ RETURN - Exits the setup menu screen.

SET UP - Displays the setup menu.

Operating CD players

Press the following buttons.

POWER - Turns on/off the power.

▶ - Starts playback.

⏸ - Pauses playback.

■ - Stops playback.

◀◀, ▶▶ - Searches for a track.

◀◀, ▶▶ - Skips a track.

0-9, +10 - Selects a track.

PRGM while pressing **SHIFT** - Enters the programmed play mode.

RANDOM while pressing **SHIFT** - Enters the random play mode.

REPEAT while pressing **SHIFT** - Enters the repeat play mode.

NOTE

There are some AIWA models that cannot be operated with the remote control, or for which some of the functions of the remote control do not work.

BEFORE OPERATION

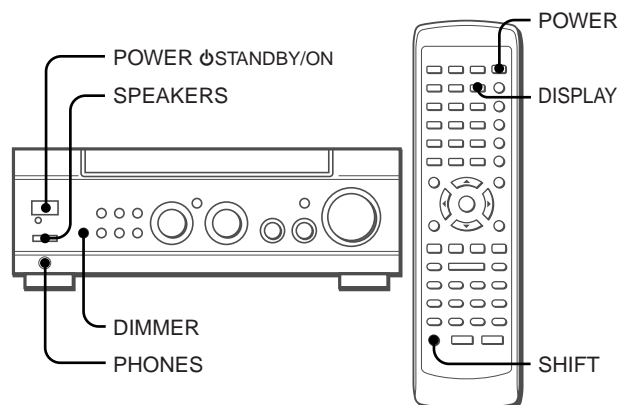

To turn the unit on

Press **POWER ⏻ STANDBY/ON (POWER)**.

The **STANDBY/ON** indicator lights in green.

Operation is possible after four seconds. The volume level or function name is displayed one after the other for the first four seconds.

To change the brightness level of the display

Press **DIMMER (hold down SHIFT and press DISPLAY) repeatedly**.

The dimmer mode changes as follows.

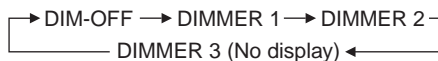

DIM-OFF: The normal display

DIMMER 1: The illumination of the display is dimmer than usual.

DIMMER 2: The illumination of the display is dimmer.

DIMMER 3 (no display): Everything on the display is cleared.

NOTE

While in the mode other than **DIM-OFF**, if you operate the receiver, the display illuminates at the **DIM-OFF** level, and after 6 seconds, the display brightness returns to the level previously set.

Note that "DIMMER" is displayed for one second before everything is cleared when the previously set level is "no display".

Using the headphones

Connect headphones with a standard stereo plug (ø6.3 mm, 1/4 inch) to the **PHONES** jack. Be sure to turn off the speakers by pressing **SPEAKERS**. Otherwise sound is output from the speakers.

To turn the unit off, press **POWER ⏻ STANDBY ON (POWER)**. The **STANDBY/ON** indicator turns to red.

CUSTOM AUDIO ADJUSTMENT

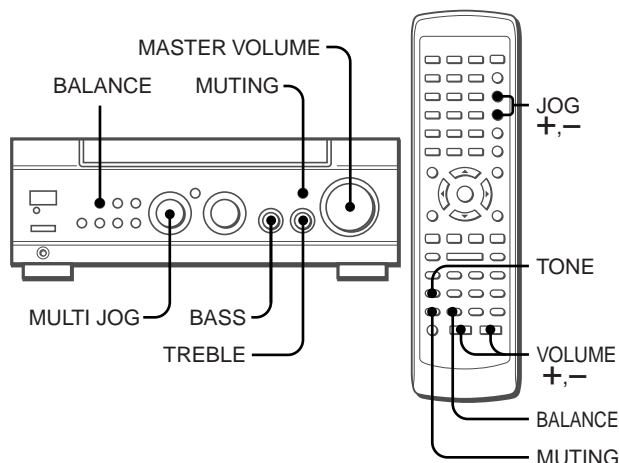

VOLUME CONTROL

Turn MASTER VOLUME (press VOLUME +, -). Adjust from 0 (minimum) to 49 and MAX (maximum). Volume level setting is retained during power-off standby. If the unit is turned off with the volume set to 21 or higher, it is automatically turned down to 20 the next time the unit is turned on.

Left and right balance of the front and surround speakers

- Press BALANCE repeatedly.
 "L/R 0dB" and "LS/RS 0dB*" appear alternately.
 "L/R 0dB" means that the left and right front speakers level is the same.
 "LS/RS 0dB*" means that the left and right surround speakers level is the same.
 Select one of them to adjust it.
 * This is not displayed in stereo mode (SURROUND off or DSP off) or when the surround speakers are set to "NONE".
- Turn MULTI JOG (press JOG +, - repeatedly).
 Example:
 "L>R 5dB" means that the left front speaker level is 5 dB higher than that of the right front speaker.
 "LS<RS 10dB" means that the right surround speaker level is 10 dB higher than that of the left surround speaker.

NOTE

- The adjustable level ranges from 0 to 10 dB.
- The surround speaker balance can be adjusted only when SURROUND or DSP is set to on and the surround speakers are not set to "NONE".

Muting the sound temporarily

Press MUTING so that "MUTE ON" appears on the display. The sound is muted.

To return to the previous volume level, press MUTING again. "MUTE OFF" is displayed.

To reset the volume and balance to the default value, press and hold BALANCE until "LVL RESET" is displayed.

All the speaker volume as well as the left and right balance of the front and surround speakers are reset to the default value (0 dB).

BASS AND TREBLE

Turn BASS or TREBLE.

The adjustable level for the bass sound and the treble sound ranges from -10 to +10 dB at 2 dB steps.

Adjusting bass and treble with the remote control

- Press TONE repeatedly to select BASS or TREBLE.
- Press JOG + or - to adjust the bass or treble level.

DSP SURROUND

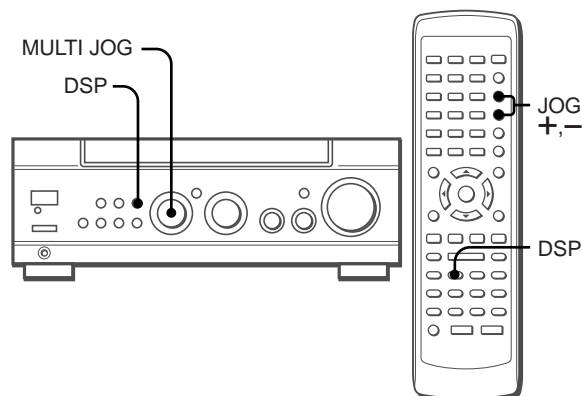

The DSP (Digital Signal Processor) surround circuits can recreate the effect of sounds reflected from walls or ceilings, to obtain the sound presence of real environments. The unit provides 5 DSP preset modes.

1 Press DSP.

2 Within 6 seconds, turn MULTI JOG to select the desired DSP mode.

The "DSP" and "S" (surround speakers) indicators light up.

→ DISCO ↔ HALL ↔ LIVE ↔ CHURCH ↔ MOVIE ←

When the music source is monaural

The DSP system may not work effectively depending on the DSP mode selected.

To cancel the selected mode

Press DSP to display the DSP mode name, and press the button again within 6 seconds. "DSP OFF" appears on the display.

To select with the remote control

- Press DSP.
- Within 6 seconds, press JOG + or - repeatedly until the desired DSP mode is displayed.

NOTE

- DSP cannot be turned on when the surround speakers are set to "NONE".
- DSP is automatically canceled when SURROUND is turned on, and vice versa.

SOUND ADJUSTMENT DURING RECORDING

The output volume and tone of the speakers or headphones may be freely varied without affecting the level of the recording.

SELECTION OF AUDIO/VIDEO SOURCE

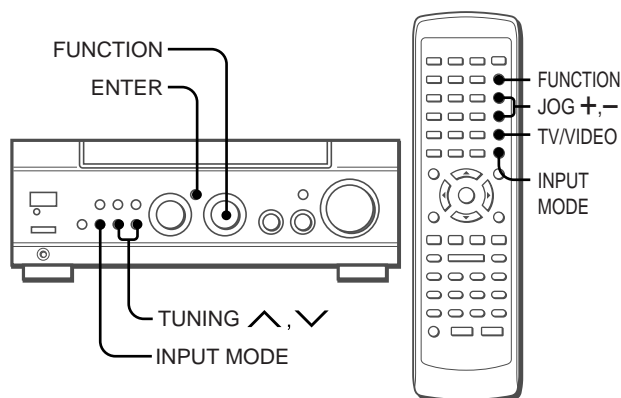

- 1 Turn FUNCTION to select the program source.**
The function changes in the following order.

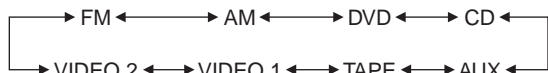

The actual source selected (except FM and AM) depends on the equipment connected to the input terminals on the rear panel of the unit.
For example, if an MD player is connected to the VIDEO 1/ MD terminals, select VIDEO 1 to listen to the MD playback sound.

To select with the remote control
Press FUNCTION repeatedly.

- 2 Start the selected program source.**
- 3 Adjust the sound.**

SELECTION OF VIDEO SOURCE

While selecting a program source which does not contain video input (such as a CD player), you can select a video source separately to be viewed on the TV.

- 1 Press FUNCTION repeatedly to select FM, AM, CD, AUX or TAPE.**
- 2 Press TV/VIDEO.**
- 3 Press JOG +, - repeatedly.**

The video source to be output through the MONITOR VIDEO OUT jack changes in the following order.



M-OUT V1: Video image of the equipment connected to the VIDEO 1/MD terminals can be viewed on the TV.
M-OUT V2: Video image of the equipment connected to the VIDEO 2/LD/TV terminals can be viewed on the TV.
M-OUT DVD: Video image of the equipment connected to the DVD terminals can be viewed on the TV.

TO CHANGE A DISPLAYED NAME FOR THE VIDEO 1 AND VIDEO 2 FUNCTION

When the VIDEO 1 function is selected, VIDEO 1 is displayed initially. It can be changed to MD.
While pressing ENTER, press INPUT MODE.
The displayed name for the VIDEO 2 function can be changed to VIDEO 2, LD or TV. Select VIDEO 2 function.
While pressing ENTER, press INPUT MODE.

TO SELECT "ANALOG" OR "DIGITAL" MODE OF THE DVD, VIDEO 1 OR VIDEO 2 FUNCTION

Press INPUT MODE when the DVD, VIDEO 1 or VIDEO 2 function is selected. The selected mode "ANALOG" or "DIGITAL" appears on the display.

In DIGITAL mode: Equipment connected to the DIGITAL IN OPTICAL (DVD) terminal is selected as a source for the DVD function, equipment connected to the DIGITAL IN OPTICAL (VIDEO 1) for the VIDEO 1 function, and equipment connected to the DIGITAL IN COAXIAL (VIDEO 2) for the VIDEO 2 function.

In ANALOG mode: Equipment connected to the DVD terminals is selected as a source for the DVD function, equipment connected to the VIDEO 1/MD for the VIDEO 1 function, and equipment connected to the VIDEO 2/LD/TV for the VIDEO 2 function.

WHEN THE “OVER LEVEL” INDICATOR LIGHTS UP

When input analog signals from the connected equipment are too high to accept, the **OVER LEVEL** indicator lights up. In this case, adjust the input level so that the indicator disappears.

To lower the sound level of the connected source

When the analog sound level of the connected source is higher than that of the FM and AM functions, adjust it as follows.

1 Select the function to be adjusted.

Turn FUNCTION and play the source.

2 Press TUNING ∇ repeatedly.

The level is decreased as follows.

0 dB \rightarrow -6 dB \rightarrow -12 dB

To restore the previous level, press TUNING \blacktriangle repeatedly.

- When the analog output of the CD player or DVD player is 2 Vrms, set the level to -6 dB.

RECORDING AN AUDIO SOURCE

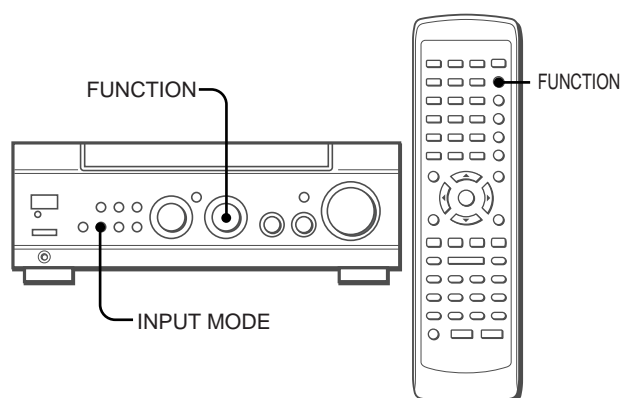

1 Select the program source to be recorded.

Turn FUNCTION (or press FUNCTION repeatedly).

2 Set the tape deck or MD recorder to recording mode.

3 Start the selected program source.

NOTE

- Any sound control system has no effect on recording (see page 9).
- Input sound through the DIGITAL IN terminals cannot be recorded. When recording the sound from the DVD, CD, MD or LD player, connect the analog AUDIO OUT terminals of the player to the corresponding AUDIO IN terminals of the receiver. The sound will be recorded in 2 ch stereo.
- Input sound from the tape deck connected to the TAPE IN terminals cannot be recorded.

MANUAL TUNING

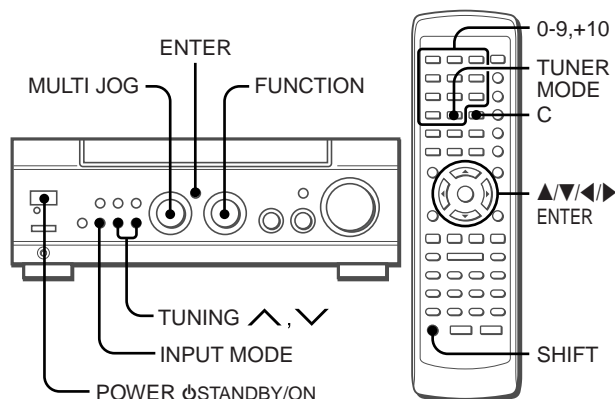

1 Turn FUNCTION to select the desired band; FM or AM.

2 Press TUNING \wedge / \vee to tune in a station.

Alternatively, press \blacktriangleleft or \blacktriangleright on the remote control.

“TUNE” is displayed when a station is tuned in.

“((()))” is displayed for FM stereo reception.

To search for a station automatically (Auto search)

Hold down TUNING \wedge or \vee (or \blacktriangleleft or \blacktriangleright).

The unit searches for a station and stops at reception.

To stop the search manually, press TUNING \wedge or \vee (or \blacktriangleleft or \blacktriangleright).

- Auto search may not stop at stations with weak signals.

When an FM stereo broadcast contains noise

Hold down SHIFT and press TUNER MODE on the remote control so that “MONO” is displayed.

Noise is reduced, although reception is monaural.

To cancel, repeat the above so that “STEREO” is displayed.

When the reception contains noise interference

Move the unit away from other electrical appliances, especially digital audio devices, or turn off the appliances that generate noise signals.

To switch the AM tuning interval

The default setting of the AM tuning interval is 10 kHz/step. If you use this unit in an area where the frequency allocation system is 9 kHz/step, change the tuning interval.

Hold down INPUT MODE and press POWER / STANDBY/ON.

To reset the interval, repeat this procedure.

NOTE

When the AM tuning interval is changed, all preset stations are cleared. The preset stations have to be set again.

PRESET TUNING

You can preset up to 32 stations and tune them in directly.

PRESETTING STATIONS

1 Tune in the desired station.

2 Press ENTER to store the station.

The preset number, beginning from “1” appears on the display.

3 Repeat steps 1 and 2 to store other stations.

The next station will not be stored if a total of 32 preset stations have already been stored. (“FULL” is displayed.)

TUNING IN PRESET STATIONS

1 Turn FUNCTION to select FM or AM.

2 Turn MULTI JOG to select a preset number.

Alternatively, press \blacktriangle or \blacktriangledown on the remote control.

You can tune in the desired preset station directly by pressing the numbered buttons on the remote control.

- To select preset number 11, press +10 and 1.

- To select preset number 25, press +10, +10 and 5.

To clear a preset station

1 Tune in the station by preset tuning.

2 Press ENTER, and press ENTER again while the frequency flashes on the display.

Alternatively, press ENTER or C on the remote control, and press ENTER while the frequency flashes on the display.

This unit is equipped with the Dolby Pro Logic decoder, Dolby Digital decoder and DTS decoder.

The unit and the center and surround speakers (standard) assure full-scale home theater sound. When playing back discs or video software that have been recorded in Dolby Pro Logic, Dolby Digital surround or DTS surround, astonishingly realistic sound surrounds the listener to create a new level of audio/visual entertainment.

Independent control of the five channels allows the listener to enjoy the same type of sound reproduction experienced in movie theaters. Voices are reproduced in the front and center sound field, while ambient sounds like cars and crowds are reproduced on all sides of the listener for an incredibly lifelike audio/video experience.

TURNING SURROUND ON AND OFF

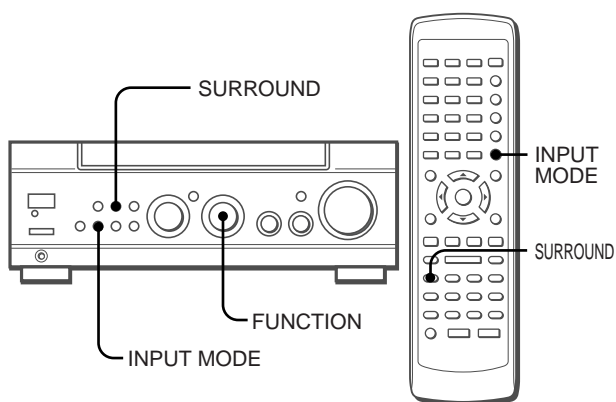

Check the followings:

- Before enjoying Dolby surround or DTS surround, set the speaker existence, size and distance (see page 14), and adjust the speaker sound levels to the proper balance (see page 15).
- Make sure the speakers are properly connected and positioned (see pages 5 and 6).
- Make sure the TV set and video unit are properly connected (see page 4).
- Make sure the disc and video tape, etc., support Dolby Pro Logic, Dolby Digital surround or DTS surround.
- When connecting an LD player equipped with the AC-3 RF OUT terminal, use an RF demodulator unit. Also connect the analog AUDIO OUT terminals of the LD player to the receiver to play all the sources. For further information, refer to the instructions of the LD player.

1 Turn FUNCTION to select a function.

2 Press INPUT MODE to select "DIGITAL" or "ANALOG".

Select in accordance with the connected equipment and sound source to be played.

3 Play the surround source by the connected equipment.

4 Press SURROUND.

Pressing the button changes the surround mode according to the type of the input signal, as follows.

In case Dolby Digital or DTS multichannel source is input:

DOLBY D or DTS ↔ 2chSTEREO

In case Dolby Digital 2-channel source or other source is input:

PRO LOGIC ↔ 2chSTEREO

The following indicators light according to the input signal and other conditions.

DIGITAL : Dolby Digital signal is input.

dts : DTS source signal is input.

PRO LOGIC : 2-channel source is played with surround set to on.

If you feel that the surround effect is not sufficient

Surround playback is affected by many factors. Check the following points.

- Are settings made correctly according to the connected speakers and their position?
- Is the DVD digital out signal correctly selected?
- In Dolby Digital and DTS, there are multi-sources other than 5.1ch. Confirm the type of the source being played.
- A disc may contain multiple audio tracks. Confirm the audio track being played.
- Dolby Digital and DTS sources can be enjoyed only when connections are made in digital.

NOTE

- This unit supports input signals of the Dolby Digital surround bit stream, DTS surround bit stream and linear PCM whose sampling frequency is 32 kHz, 44.1 kHz and 48 kHz.
- When connecting some DVD players to the receiver through the digital in terminals, noise may be heard in the DVD operation: e.g. searching a disc, skipping a chapter.

SETTING SPEAKER SIZE AND DISTANCE

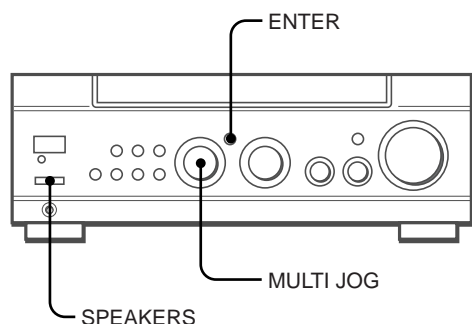

Set the speaker size (large or small) and the speaker distance (distance between the speaker and the listening position), as well as speaker existence, correctly as described below.

Default settings

Default settings of the speaker size and distance are as follows:

[AV-NW30]

- “FR LARGE” (Front speakers are large.)
- “C LARGE” (Center speaker is large.)
- “SUR LARGE” (Surround speakers are large.)

[AV-NW31]

- “FR SMALL” (Front speakers are small.)
- “C SMALL” (Center speaker is small.)
- “SUR SMALL” (Surround speakers are small.)

[Common]

- “SUBW ON” (Sub woofer is turned on.)
- “FR 17FT” (Distance between the left and right front speakers and the listening position is 17 feet.)
- “C 17FT” (Distance between the center speaker and the listening position is 17 feet.)
- “SUR 12 FT” (Distance between the left and right surround speakers and the listening position is 12 feet.)

NOTE

- When “FR SMALL” is selected, “SUBW ON” is selected automatically.
When the front speakers are small, be sure to connect the sub woofer; otherwise the bass sound will not be emitted.
- When “FR SMALL” is selected, “C LARGE” and “SUR LARGE” cannot be selected.

First make sure that “BY-PASS ON” is not set for DTS.

1 Press and hold SPEAKERS until “FR LARGE” is displayed.

2 Within 6 seconds, turn MULTI JOG.

The adjustable items are displayed cyclically as follows:

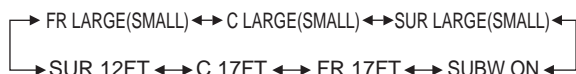

3 When the item to be adjusted is displayed, press ENTER.

The adjustable size (or distance) flashes.

4 Within 6 seconds, turn MULTI JOG to adjust the size (or distance), and press ENTER.

Selectable sizes and distances

[Front speakers]

- “LARGE” : larger size
- “SMALL” : smaller size

[Center speaker]

- “LARGE” : larger size
- “SMALL” : smaller size
- “NONE” : no center speaker

[Surround speakers]

- “LARGE” : larger size
- “SMALL” : smaller size
- “NONE” : no surround speakers

LARGE : Frequencies (sounds) over all the band of the channel is output.
SMALL : Frequencies (sounds) under 90 Hz are not output. They are re-directed to the sub woofer or other large speakers.

[Sub woofer]

- “ON” : sub woofer activated
- “OFF” : sub woofer deactivated or no sub woofer

[Distance between the front speakers and the listening position]

From “1” foot to “30” feet with 1 foot step

[Distance between the center speaker and the listening position]

From “1” foot to “30” feet with 1 foot step

[Distance between the surround speakers and the listening position]

From “1” foot to “30” feet with 1 foot step

NOTE

- When setting the speaker distance, first set the front speakers distance. The center speaker distance then can be set between the distance equal to the front speaker distance and the distance 5 feet shorter than the front speaker distance. Also, the surround speakers distance can be set between the distance equal to the front speaker distance and the distance 15 feet shorter than the front speaker distance.
- Adjust the center speaker distance so that the voices are heard from the center position.
- Adjust the surround speakers distance freely according to your preference.
- When the front speakers distance is changed, the center and surround speakers distance may automatically be modified.

ADJUSTING SPEAKER LEVEL BALANCE

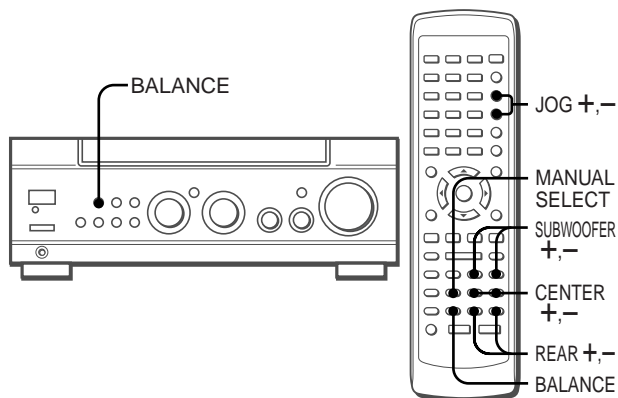

The unit is equipped with a built-in test signal generator called a noise sequencer for easy balance adjustment of all five channels. The sequencer outputs a noise signal that “travels” from channel to channel, enabling the simple adjustment of sound level to achieve the same apparent loudness, at your listening position, from each channel.

Preparation

- Before adjusting the speaker level balance, be sure to set the speaker size, distance and existence correctly.
- Before adjusting the speaker level balance, turn off the DSP surround system.
- Operate the unit while playing the source recorded in Dolby Digital surround or Dolby Pro Logic.

1 Turn SURROUND on.

2 Press and hold MANUAL SELECT on the remote control until “L” or “L/R 0dB” starts to flash.

A noise signal is sent to each channel in turn at the interval of 2 seconds as follows:

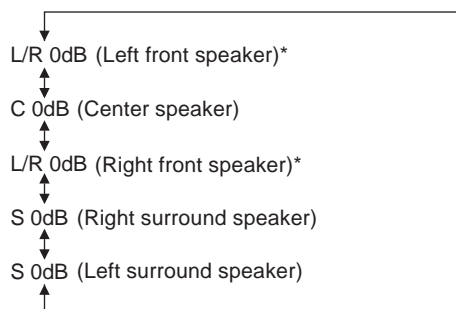

* L or R flashes to indicate one of the front speakers from which the noise signal is output.

3 Adjust the sound level of the center and surround speakers.

While “C” or “S” flashes in the display, press JOG + or – on the remote control so that the sound level of the center or surround speakers matches that of the front speakers. The balance of the front speakers can be adjusted as well while “L/R” is displayed.

4 Press MANUAL SELECT again to stop the noise signal.

NOTE

- When the noise signal cycles through all the speakers for ten times, the noise signal stops automatically.
- When the center speaker and/or surround speakers are set to “NONE”, their level balance cannot be adjusted. (“C 0dB” and “S 0dB” are not displayed.)

About the channels

The left and right front speakers create the stereo effect.

The center speaker helps precise sound positioning over a broad sound field.

The surround speakers enhance the “depth” of the sound field.

CHANGING SPEAKER VOLUME TEMPORARILY

According to the software played or your preference, you can change the sub woofer, center speaker and surround speakers volume temporarily.

Press SUBWOOFER +/-, CENTER +/- or REAR +/- on the remote control.

Each speaker level can be changed within the range from –10 dB to +10 dB at 1 dB steps.

To restore the volume and balance to the default value

Press and hold BALANCE until “LVL RESET” is displayed.

All the speaker volume as well as the left and right balance of the front and surround speakers are reset to the default value (0 dB).

OTHER SETTINGS

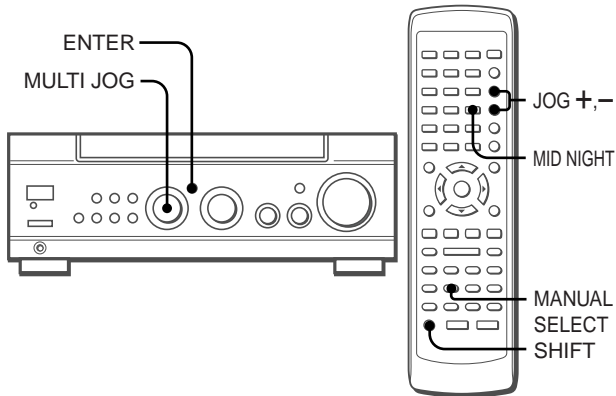

ADJUSTING LOW FREQUENCY SOUND EFFECT (LFE)

The disc recorded in Dolby Digital surround contains special signals called LFE to enhance low frequency sound effect. The LFE signals are recorded in some particular parts on the disc and output from the connected sub woofer to reproduce astonishingly powerful low sound. The sound level of the LFE signals can be adjusted according to your speakers.

Preparation

Play a disc recorded in Dolby Digital surround.

- 1 Press MANUAL SELECT on the remote control.**
"LFE" is displayed.
- 2 Press JOG + or - to adjust the LFE level.**
The unit is initially set to 0 dB (maximum) and can be adjusted as follows:
OFF ↔ -10 dB ↔ -5 dB ↔ 0 dB
MULTI JOG on the unit is also available.

When selecting "SUBW OFF", the LFE signals are redistributed to other speakers.

ADJUSTING DYNAMIC RANGE

Dynamic range of the sound can be adjusted. The unit is initially set to "STD" (standard) mode.

Preparation

Play a disc recorded in Dolby Digital surround.

- 1 Hold down ENTER (hold down SHIFT and press MID NIGHT).**
"MID NIGHT THEATER" runs through on the display.
- 2 Turn MULTI JOG (press JOG + or -) to select "MIN", "MAX" or "STD".**

MIN: You can enjoy the full dynamic range of sound like in the movie theater.
STD: Original position, when playing back in home, that is recommended by the software producers.
MAX: Select this mode when playing back at low volume.

TO LISTEN TO THE ORIGINAL DTS SOUND

When "dts" appears on the display, all the sound settings can be canceled.

Preparation

Play a disc recorded in DTS surround.

- 1 Press ENTER.**
"BY-PASS OFF" is displayed.
- 2 Press ENTER again so that "BY-PASS ON" is displayed.**

To restore the sound settings

Repeat steps 1 and 2 so that "BY-PASS OFF" appears.

To operate with the remote control

Hold down SHIFT and press MID NIGHT repeatedly.

SETTING THE SLEEP TIMER

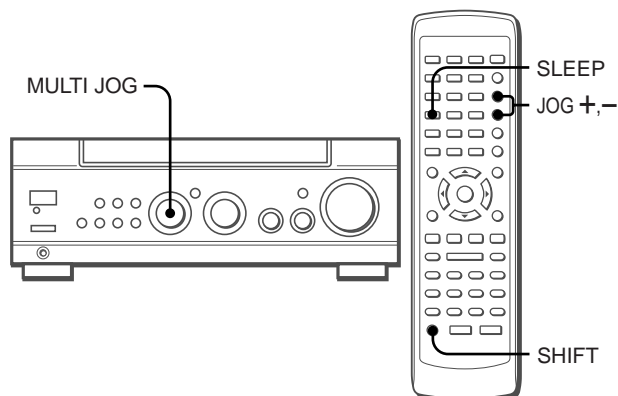

The unit can be automatically turned off at a specified time.

1 Hold down **SHIFT** and press **SLEEP** on the remote control.

"SLEEP" is displayed.

2 Within 6 seconds, press **JOG +** or **-** repeatedly to set the sleep timer duration.

With each press, the timer duration changes in 5-minute steps between 5 to 240 minutes. If there is no button input for 6 seconds, the current setting is entered automatically.

The unit turns off after the selected time.

- MULTI JOG on the unit is also available.

To check the remaining time until the unit turns off

Hold down **SHIFT** and press **SLEEP** on the remote control.

The remaining time is displayed for 6 seconds.

To cancel the sleep timer

Hold down **SHIFT** and press **SLEEP** on the remote control repeatedly so that "**SLEEPoFF**" is displayed.

CARE AND MAINTENANCE

Occasional care and maintenance of the unit is needed to optimize the performance of your unit.

To clean the cabinet

Use a soft dry cloth.

If the surfaces are extremely dirty, use a soft cloth lightly moistened with mild detergent solution. Do not use strong solvents, such as alcohol, benzine or thinner as these could damage the finish of the unit.

TROUBLESHOOTING GUIDE

If the unit fails to perform as described in these Operating Instructions, check the following guide.

GENERAL

There is no sound.

- Is the AC cord connected properly?
- Is there an incorrect connection? (→ pages 4-6)
- There may be a short circuit in the speaker terminals.
 - Disconnect the AC cord, then correct the speaker connections.
- Was an incorrect function selected?

Is SPEAKER set correctly? (→ page 8)

Sound is emitted from one speaker only.

- Is BALANCE set appropriately?
- Is the other speaker disconnected?

Sound is heard at a very low volume.

- Has MUTING been pressed?

An erroneous display or a malfunction occurs.

- Reset the unit as stated below.

TUNER SECTION

There is constant, wave-like static.

- Is the antenna connected properly? (→ page 6)
- Is the FM signal weak?
 - Connect an outdoor antenna.

The reception contains noise interference or the sound is distorted.

- Is the system picking up external noise or multipath distortion?
 - Change the orientation of the antenna.
 - Move the unit away from other electrical appliances.

To reset

If an unusual condition in the display window or malfunction occurs, reset the unit as follows:

- 1 Press **POWER** ϕ **STANDBY/ON** to turn off the power.
- 2 Press **POWER** ϕ **STANDBY/ON** while pressing **ENTER**.
Everything stored in memory after purchase is canceled.

If the power cannot be turned off in step 1 because of a malfunction, disconnect the AC cord, and reconnect the AC cord after several seconds. Then carry out step 2.

SPECIFICATIONS

FM tuner section

Tuning range	87.5 MHz to 108 MHz
Usable sensitivity (IHF)	13.2 dBf
Antenna terminal	75 ohms (unbalanced)

AM tuner section

Tuning range	530 kHz to 1710 kHz (10 kHz step) 531 kHz to 1602 kHz (9 kHz step)
Usable sensitivity	350 μ V/m
Antenna	Loop antenna

Amplifier section

Power output	Front 100 W + 100 W (1 kHz, T.H.D. less than 0.9%, 8 ohms) 120 W + 120 W (1 kHz, T.H.D. less than 10%, 8 ohms) 75 W + 75W (20 Hz – 20 kHz, T.H.D. less than 0.9%, 8 ohms) Rear (surround) 100 W + 100 W (1 kHz, T.H.D. less than 0.9%, 8 ohms) 120 W + 120 W (1 kHz, T.H.D. less than 10%, 8 ohms) 75 W + 75W (20 Hz – 20 kHz, T.H.D. less than 0.9%, 8 ohms) Center 100 W (1 kHz, T.H.D. less than 0.9%, 8 ohms) 120 W (1 kHz, T.H.D. less than 10 %, 8 ohms) 75 W (20 Hz – 20 kHz, T.H.D. less than 0.9%, 8 ohms)
---------------------	---

Total harmonic distortion

0.1% (70W, 1 kHz, 8 ohms, front)

Inputs

AUDIO IN
DVD: 350 mV, adjustable (47 kohms)
VIDEO 2/LD/TV: 350 mV, adjustable (47 kohms)
VIDEO 1/MD: 350 mV, adjustable (47 kohms)
TAPE: 350 mV, adjustable (47 kohms)
AUX: 350 mV, adjustable (47 kohms)
CD: 350 mV, adjustable (47 kohms)
DIGITAL IN
COAXIAL (VIDEO 2):
OPTICAL (VIDEO 1):
OPTICAL (DVD):
accept linear PCM signals and bit stream of Dolby Digital and DTS surround (32 kHz, 44.1 kHz and 48 kHz)
VIDEO IN
DVD: 1 Vp-p (75 ohms)
VIDEO 2/LD/TV: 1 Vp-p (75 ohms)
VIDEO 1/MD: 1 Vp-p (75 ohms)

Outputs

AUDIO OUT
VIDEO 1/MD: 350 mV (1 kohm)
TAPE: 350 mV (1 kohm)
VIDEO OUT
VIDEO 1/MD: 1 Vp-p (75 ohm)
MONITOR: 1 Vp-p (75 ohm)
SUB WOOFER: 4.0 V
FRONT SPEAKERS: accept speakers of 8 ohms or more.
SURROUND SPEAKERS: accept speakers of 8 ohms or more.
CENTER SPEAKER: accept speaker of 8 ohms or more.
PHONES (stereo jack): accepts headphones of 32 ohms or more
-20 dB

Muting

General

Power requirements	120 V AC, 60 Hz
Power consumption	185 W
Dimensions (W x H x D)	430 x 155.5 x 345.5 mm (17 x 6 1/8 x 13 5/8 in.)
Weight	7.7 kg (17 lb)

Specifications and external appearance are subject to change without notice.

- Manufactured under license from Dolby Laboratories. "Dolby", "Pro Logic" and the double-D symbol are trademarks of Dolby Laboratories.
- "DTS" and "DTS Digital Surround" are registered trademarks of Digital Theater Systems, Inc.



As an ENERGY STAR® Partner, AIIWA has determined that this product meets the ENERGY STAR® guidelines for energy efficiency.

PARTS INDEX

Instruction about each part on the unit or remote control are indicated on the pages listed (in alphabetical order) below.

On the unit

BALANCE	9, 15
BASS	9
DIMMER	8
DSP	9
ENTER	6, 7, 10, 12, 14, 16
FUNCTION	10 - 13
INPUT MODE	10 - 13
MASTER VOLUME	9
MULTI JOG	6, 9, 12, 14, 16, 17
MUTING	9
PHONES	8
POWER ϕ STANDBY/ON	8, 12
SPEAKERS	6, 8, 14
SURROUND	13
TREBLE	9
TUNING \wedge, \vee	11, 12

On the remote control

AUDIO/1	7, 12
ANGLE/3	7, 12
BALANCE	9, 15
CD	7
CENTER $+,-$	15
DISPLAY/6	8, 12
DSP	9
DVD	7
FUNCTION	7, 10, 11
ENTER	7
INPUT MODE	10
JOG $+,-$	9, 10, 15 - 17
MANUAL SELECT	15, 16
MENU	7
MID NIGHT/C	7, 12, 16
MUTING	9
ON SCREEN/4	7, 12
POWER	7, 8
PRESET TV CH \wedge/\blacktriangle	7, 12
PRESET TV CH \vee/\blacktriangledown	7, 12
PRGM/7	7, 12
RANDOM/8	7, 12
REAR $+,-$	15
REPEAT/9	7, 12
SET UP	7
SHIFT	7, 8, 12, 16, 17
SLEEP/+10	12, 17
SLOW $\lll, \lll/\lll, \lll$	7
SUB TITLE/2	7, 12
SUBWOOFER $+,-$	15
SURROUND	13
TONE	9
TOP MENU	7
TUNER	7
TUNER MODE/0	12
TUNING/TV VOL $+/\blacktriangleright$	7, 12
TUNING/TV VOL $-/\blacktriangleleft$	7, 12
TV	7
TV/VIDEO	7, 10
VIDEO 1	7
VIDEO 2	7
VOLUME $+,-$	9
ZOOM/5	7, 12
\circ RETURN	7
\lll, \lll	7
\blacksquare	7
\blacktriangleright	7
\lll	7

NOTE

This equipment has been tested and found to comply with the limits for a Class B digital device, pursuant to Part 15 of the FCC Rules. These limits are designed to provide reasonable protection against harmful interference in a residential installation.

This equipment generates, uses, and can radiate radio frequency energy and, if not installed and used in accordance with the instructions, may cause harmful interference to radio communications. However, there is no guarantee that interference will not occur in a particular installation. If this equipment does cause harmful interference to radio or television reception, which can be determined by turning the equipment off and on, the user is encouraged to try to correct the interference by one or more of the following measures:

- Reorient or relocate the receiving antenna.
- Increase the separation between the equipment and receiver.
- Connect the equipment into an outlet on circuit different from that to which the receiver is connected.
- Consult the dealer or an experienced radio/TV technician for help.

CAUTION

Modifications or adjustments to this product, which are not expressly approved by the manufacturer, may void the user's right or authority to operate this product.

AIWA CO.,LTD.

 <http://www.aiwa.co.jp>

For assistance and information **call toll free 1-800-BUY-AIWA** (United States and Puerto Rico)